

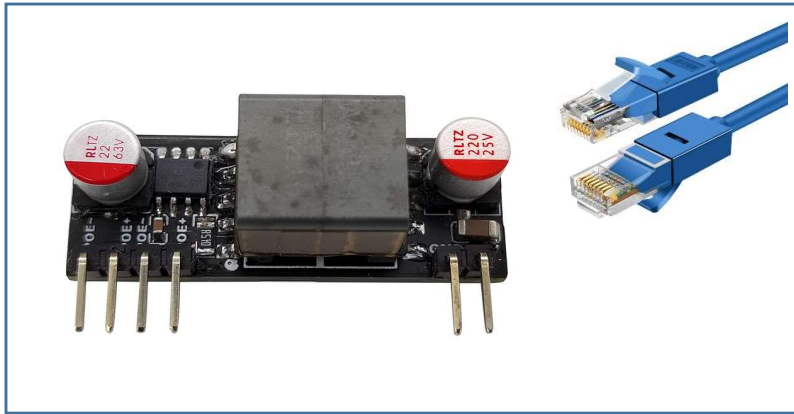

TAG TECHNOLOGY CO., LTD.





PoE Module Family

- Compliant With IEEE802.3 af/at/bt Standard
- Maximum 70W 12v or 24v output power
- Complete PD solution with minimal (low cost) external components required
- Transformer isolation ,1500V isolation (input to output)
- Differential Mode Common Mode 4KV Surge Protection.
- Input voltage range 36V to 57V
- Low output ripple and noise

TAG designs and develops a wide range of PoE Power Device (PD) modules. Manufactured in a variety of sizes, output powers, and output voltages to suit a wide range of applications, TAG's PoE modules require minimal external components and all have built-in Signature recognition in compliance with the IEEE802.3 af/at/bt specification.

To extend the range of applications, many of TAG's modules offer different output voltage options and include module overheat protection; all modules have adjustable output voltage derangement/overload/short-circuit protection, and are available in SIL single-pin, DIL double-pin, and SMT packages. These PoE modules are cost-effective and can be used in a variety of applications, such as VoIP (Voice over Internet Protocol) phones (IP Phone), IP Camera, Wireless Router, Access Control, Point of Sales, POS, Digital Point of Sale (DPS), and other applications. Sales (POS), Digital Sinage, ...etc.

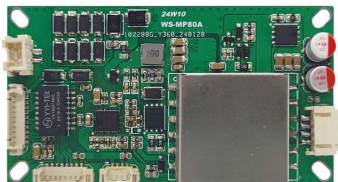
ELECTRICAL SPECIFICATIONS:

| Product Family | Part No | Nominal Output Voltage | Max OutputPower | Benefits |
|---|------------|------------------------|-----------------|---|
|  | PDT1270001 | 12V | 70W | 1, conforming to the IEEE 802.3af/at/bt Power-over-Ethernet (PoE) standard 2, maximum output power 71W, full power output 3, lightning protection 4KV/ anti-static/anti-surge protection 4, industrial grade temperature resistance -45~80 degrees 5, industrial grade chip, shielded transformer 6, PCBA size: 84mm x 45mm x 15mm |
|  | PDT1260001 | 12V | 60W | 1, conforming to the IEEE 802.3af/at/bt Power-over-Ethernet (PoE) standard 2, large output power 12V@5A 3, lightning protection 4KV/ anti-static/anti-surge protection 4, Operating temperature -40 to +75°C 5, POE standard protocol chip 6, PCBA size: 40mm x 130mm x 15mm |

HEAD OFFICE : Taiwan

TEL : 886 2 2791 9208

FAX : 886 2 2791 9271

E -mail : sales-tw@tag-tech.cn

ShenZhen

TEL: 86 755 2265 4565

FAX: 86 755 2265 4561

URL:www.tag-tech.cn





Dongguan

TEL: 86 769 8298 9853

FAX: 86 769 8280 2057

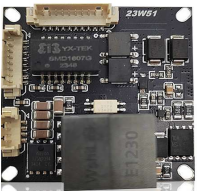
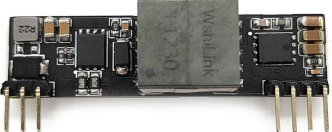

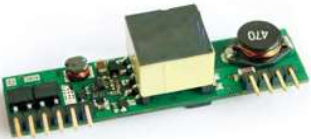
TAG TECHNOLOGY CO., LTD.

| Product Family | Part No | Nominal Output Voltage | Max Output Power | Benefits |
|---|------------|------------------------|------------------|---|
|  | PDT1230001 | 12V | 30W | <ol style="list-style-type: none"> 1, conforming to the IEEE 802.3af/at/bt Power-over-Ethernet (PoE) standard 2, large output power 12V@2.5A 3, lightning protection 4KV/ anti-static/anti-surge protection 4, Operating temperature -40 to +75°C 5, POE standard protocol chip 6, PCBA size: 38mm x 38mm x 17mm |
|  | PDT1225001 | 12V | 25W | <ol style="list-style-type: none"> 1, conforming to the IEEE 802.3af/at/bt Power-over-Ethernet (PoE) standard 2, large output power 12V@2A 3, lightning protection 4KV common mode difference mode, shielded isolation transformer 4, anti-static, anti-surge protection 5, POE standard protocol chip 6, PCBA size: 53mm x 14mm x 18mm |
|  | PDT1225002 | 12V | 25W | <ol style="list-style-type: none"> 1, conforming to the IEEE 802.3af/at Power-over-Ethernet (PoE) standard 2, large output power 12V@2A 3, lightning protection 4KV common mode difference mode, shielded isolation transformer 4, POE standard protocol chip 5, PCBA size: 38mm x 38mm x 16.5mm |
|  | PDT1215001 | 12V | 15W | <ol style="list-style-type: none"> 1, conforming to the IEEE 802.3af/at Power-over-Ethernet (PoE) standard 2, large output power 12V@1A 3, POE standard protocol chip 4, PCBA size: 56mm x 14mm x 16mm |
|  | PDT1215001 | 12V | 15W | <ol style="list-style-type: none"> 1, conforming to the IEEE 802.3af/at Power-over-Ethernet (PoE) standard 2, large output power 12V@1A 3, lightning protection 4KV/ anti-static/anti-surge protection 4, anti-static, anti-surge protection 5, POE standard protocol chip 7, PCBA size: 38mm x 14.5mm x 16.5mm |

HEAD OFFICE : Taiwan

TEL : 886 2 2791 9208

FAX : 886 2 2791 9271

ShenZhen

TEL: 86 755 2265 4565

FAX: 86 755 2265 4561

Dongguan

TEL: 86 769 8298 9853

FAX: 86 769 8280 2057

E-mail : sales-tw@tag-tech.cn

URL: www.tag-tech.cn



TAG TECHNOLOGY CO., LTD.

Ordering Information:

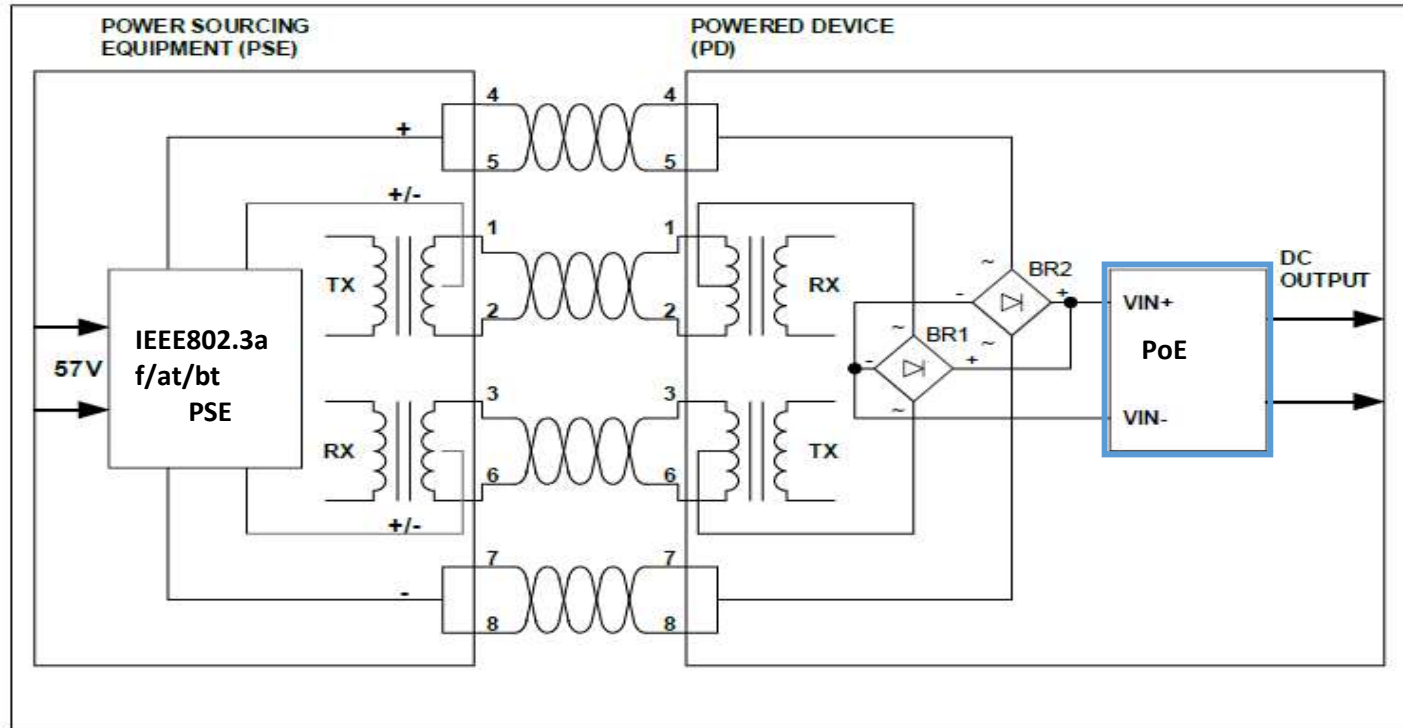

HEAD OFFICE : Taiwan

TEL : 886 2 2791 9208

FAX : 886 2 2791 9271

ShenZhen

TEL: 86 755 2265 4565

FAX: 86 755 2265 4561

Dongguan

TEL: 86 769 8298 9853

FAX: 86 769 8280 2057

E -mail : sales-tw@tag-tech.cn

URL: www.tag-tech.cn